

KOMATSU®

WA470-8

EPA Tier 4 Final Engine

Australia & New Zealand Specifications

WHEEL LOADER

WA470



Photos may include optional equipment.

NET HORSEPOWER

203 kW/ 272 HP @2000 rpm

OPERATING WEIGHT

24,350 – 25,210 kg

BUCKET CAPACITY

3.8 – 4.65 m³

WALK-AROUND



WA470-8

Photos may include optional equipment.

NET HORSEPOWER

203 kW/ 272 HP @2000 rpm

OPERATING WEIGHT

24,350 – 25,210 kg

BUCKET CAPACITY

3.8 – 4.65 m³

PERFORMANCE, DURABILITY AND FUEL ECONOMY

Large capacity torque converter with lock-up:

- Quick acceleration
- Lock-up in 2nd, 3rd and 4th gear

Komatsu SmartLoader Logic helps reduce fuel consumption with no decrease in production.



A powerful **Komatsu SAA6D125E-7 engine** provides a net output of 203 kW 272 HP with 6% improved fuel consumption. This engine is EPA Tier 4 Final emissions certified.

Variable Geometry Turbocharger (VGT) uses a hydraulic actuator to provide optimum air flow under all speed and load conditions.

Komatsu Diesel Particulate Filter (KDPF) and Selective Catalytic Reduction (SCR) systems reduce particulate matter and NOx while providing automatic regeneration that does not interfere with daily operation.

Fluid neutral or better

Fuel & DEF total consumption is less than fuel consumed by the prior model.

Cooling

- Hydraulically driven, variable speed
- Auto-reversing fan is standard
- Wider core coolers resist clogging
- Swing out fan for easy cleaning

Remote boom and bucket positioners can set kick-outs from inside the cab.

Variable displacement piston pumps with CLSS provides quick response and smooth operation to maximise productivity.

Rearview monitoring system (standard)

Advanced diagnostic system continuously monitors machine operation and vital systems to identify machine issues and assist with troubleshooting.

Transmission Mode Select System (3 modes) allows shifting mode to be matched more efficiently to varying work applications.

Enhanced working environment:

- High capacity air suspension seat, heated
- Seat mounted EPC controls with F-N-R switch
- (2) 12V power outlets

New style of front fender is plastic for durability.

Rear full fenders (standard) are made of durable plastic and swing open for easy access to maintenance points.

Large LCD colour monitor panel:

- 7" high resolution, multi-colour screen is easy to read
- Provides "Ecology Guidance" for fuel efficient operation
- Onboard diagnostics do not require use of a laptop computer
- Multiple choice, pulldown menus are filled with useful functions

Komatsu Auto Idle Shutdown helps reduce idle time and operating costs.

External mounting of engine air filter (above rear LH fender) provides easy access for maintenance.

KOMTRAX® equipped machines can send location, SMR and operation maps to a secure website or smart phone utilising wireless technology. Machines also relay error codes, cautions, maintenance items, fuel & Diesel Exhaust Fluid (DEF) levels, and much more.

Lockable battery isolation switch allows a technician to disconnect the power supply before servicing the machine.

Operator Identification System can track machine operation for up to 100 operators.

PERFORMANCE FEATURES

KOMATSU NEW ENGINE TECHNOLOGIES

New Tier 4 Final Engine

The Komatsu SAA6D125E-7 engine is EPA Tier 4 Final emissions certified and provides exceptional performance while reducing fuel consumption. Based on Komatsu proprietary technologies developed over many years, this new diesel engine reduces nitrogen oxides (NOx) by more than 80% when compared to Tier 4 interim levels.

Technologies Applied to New Engine

Heavy-duty aftertreatment system

This new system combines a Komatsu Diesel Particulate Filter (KDPF) and Selective Catalytic Reduction (SCR). The SCR NOx reduction system injects the correct amount of Diesel Exhaust Fluid (DEF) at the proper rate, thereby decomposing NOx into non-toxic water vapour (H₂O) and nitrogen gas (N₂).

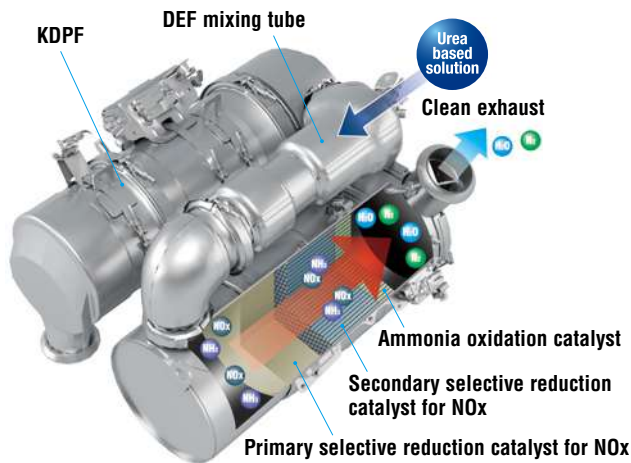

Heavy-duty cooled Exhaust Gas Recirculation (EGR) system

The system recirculates a portion of exhaust gas into the air intake and lowers combustion temperatures, thereby reducing NOx emissions. EGR gas flow has been decreased for Tier 4 Final with the addition of SCR technology. The system dramatically reduces NOx, while helping cut fuel consumption below Tier 4 Interim levels.

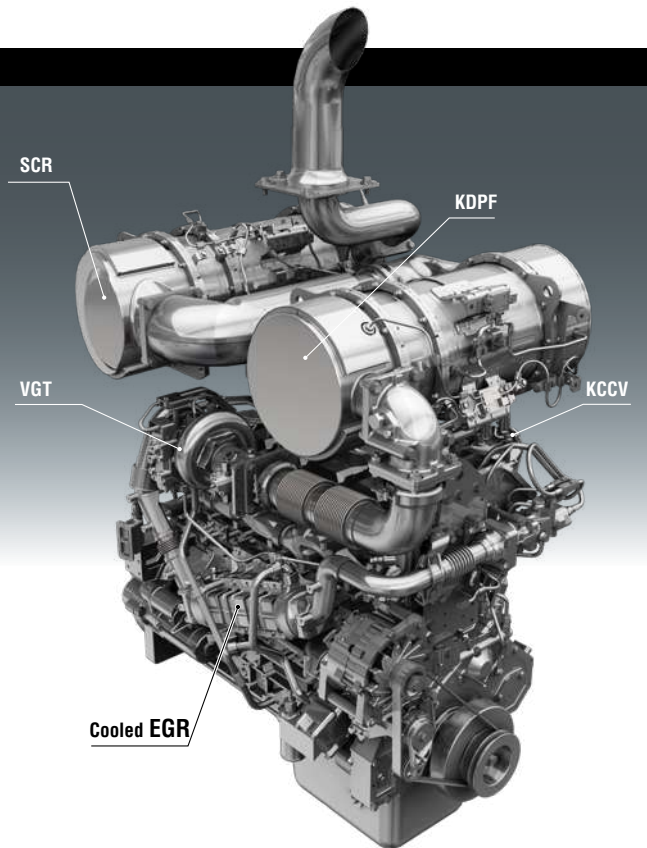
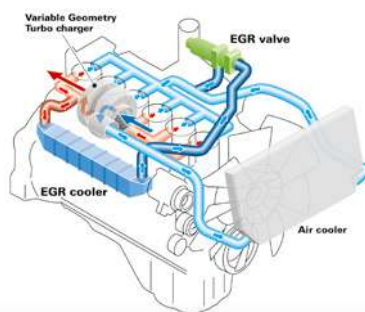

Advanced Electronic Control System

The electronic control system performs high-speed processing of all signals from sensors installed in the vehicle providing total control of equipment. Engine condition information is displayed on the monitor inside the cab, providing necessary information to the operator. Additionally, managing the information via KOMTRAX helps customers keep up with required maintenance.

Variable Geometry Turbocharger (VGT) system

The VGT system features proven Komatsu design hydraulic technology for variable control of air-flow and supplies optimal air according to load conditions. The upgraded version provides better exhaust temperature management.

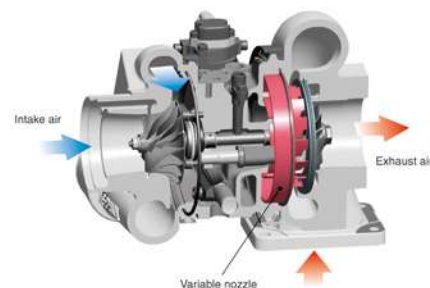

WA470-8

Heavy-duty High-Pressure Common Rail (HPCR) fuel injection system

The system is designed to achieve an optimal injection of high-pressure fuel digitally, thereby bringing near complete combustion to reduce PM emissions.

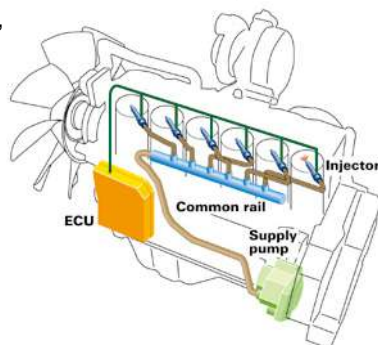

Komatsu SmartLoader Logic

The WA470-8 provides Komatsu SmartLoader Logic, an engine control system. This technology creates enough torque for each work phase. For example, engine torque needs are higher for digging in V-shape loading, but less when driving with an empty bucket. This system optimises the engine torque for all applications to minimise fuel consumption. Komatsu SmartLoader Logic functions automatically and doesn't interfere with operation, saving fuel without decreasing production.

Large-capacity Torque Converter

The Komatsu designed power train has a large capacity torque converter for optimum efficiency. The WA470-8 has greater productivity in V-shape loading applications because the increased tractive effort does not require full throttle. The improved hill climbing ability allows the WA470-8 to up-shift gears faster because of improved acceleration. The WA470-8 can achieve higher gear ranges and maintain higher travel speed when working in load-and-carry applications. In most applications, production is increased and fuel consumption is reduced, resulting in improved fuel efficiency.

Enhanced Lock-up

The Komatsu designed torque converter with lock-up is standard on the WA470-8. The lock-up function activates in 2nd, 3rd and 4th gears. The lock-up torque converter is effective for both load and carry application and V-shape loading which uses lower gears. Komatsu SmartLoader Logic reduces the clutch engagement shock of lock-up by controlling engine torque. The lock-up torque converter combined with Komatsu SmartLoader Logic results in low fuel consumption and high travel speeds in load and carry and even some V-cycle loading applications.

Dual-mode Engine Power Select System

This wheel loader offers two selectable operating modes — E and P.

- E Mode: This mode provides maximum fuel efficiency for general loading.
- P Mode: This mode provides maximum power output for hard digging operation or hill climbing.



- 1 Dual mode engine power selection switch
- 2 Transmission shift mode selector switch
- 3 Torque converter lock-up switch

Automatic Transmission with Mode Select System

This operator controlled system allows the operator to select manual shifting or two levels of automatic shifting (low, and high). Auto L mode is for fuel saving operation with the gear shift timing set at lower speeds than Auto H mode. Therefore Auto L mode keeps the engine in a relatively low rpm range for fuel conservation while yielding required tractive force by operator depressing the accelerator pedal.

Variable Displacement Piston Pump & CLSS

The variable displacement piston pump combined with the Closed-centre Load Sensing System (CLSS) delivers hydraulic flow just as the job requires preventing wasted hydraulic flow. Minimised loss contributes to better fuel economy.

Komatsu Auto Idle Shutdown

In order to reduce idle time, Komatsu offers Komatsu Auto Idle Shutdown. This function will shut the engine off and apply the parking brake and hydraulic lock after a preset idle time limit.

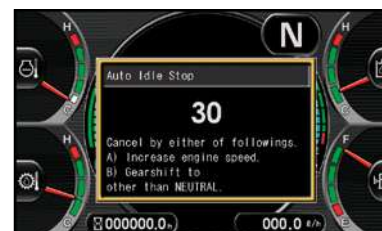

OPERATOR ENVIRONMENT

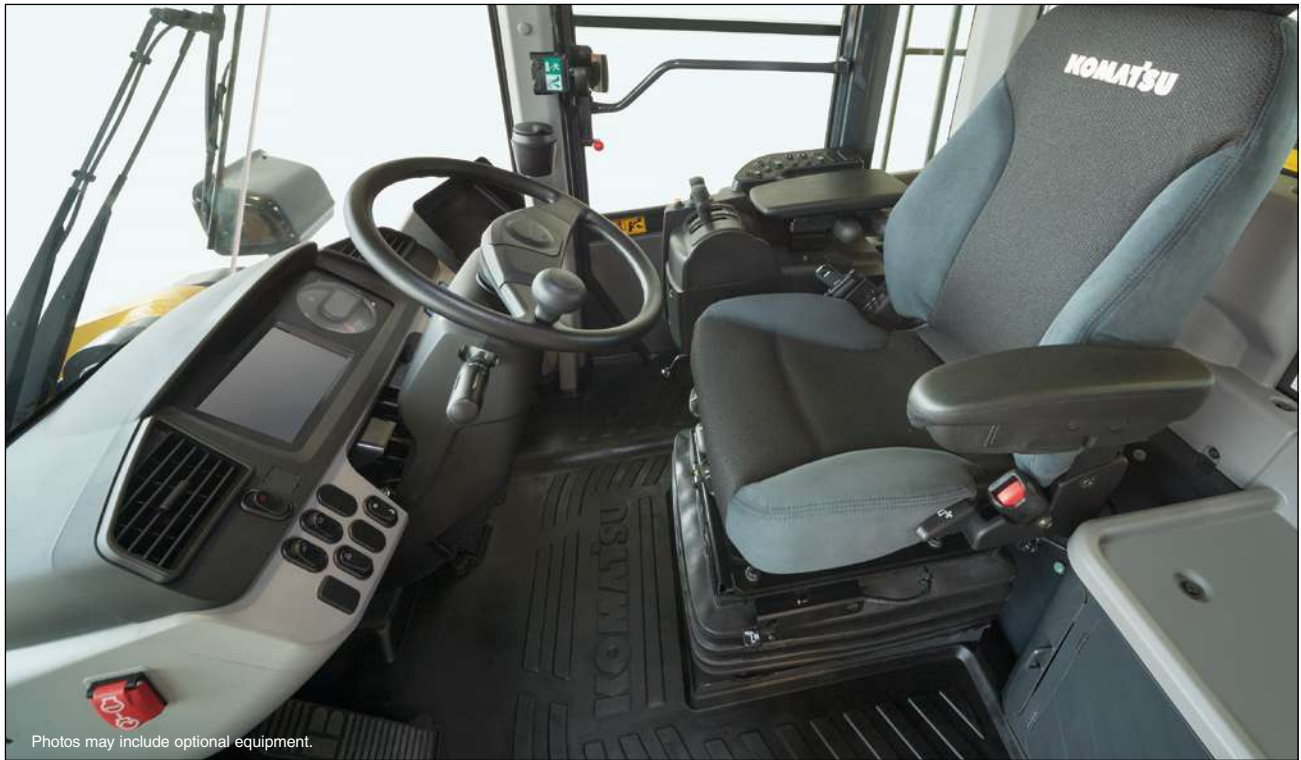

Photos may include optional equipment.

New Operator Seat with Electronic Pilot Control (EPC) Levers

A new air suspension seat provides enhanced support on rough roads and dampens machine vibrations, providing a more comfortable ride for the operator. An EPC lever console is integrated in the seat and moves with the seat. The angle of the armrest is fully adjustable for optimum operator comfort. A secondary F-N-R switch is incorporated in work equipment lever configurations. A heated seat is standard.



Tiltable / Telescopic Steering Wheel

The operator can both tilt and telescope the steering wheel to allow maximum comfort and control. The two spoke steering wheel allows maximum visibility of the monitor panel and the forward work environment.



Low Noise Design

Operator's ear noise level : 72 dB(A)
Dynamic noise level (outside): 108 dB(A)

The large cab is mounted with Komatsu's unique ROPS/FOPS viscous mounts. The low-noise engine, hydraulically driven fan, and hydraulic pumps are mounted with rubber cushions, and the cab sealing is improved to provide a quiet, low-vibration, dustproof, and comfortable operating environment.



Joystick/Wheel Steering Control System (optional)

allows steering and directional travel to be controlled by wrist and finger control to minimise operator fatigue.





Photos may include optional equipment.

Rear View Monitoring System (standard)

The operator can view the rear of the machine with a full colour monitor that is located on the right side of the cab. This monitor can be always on or only on when the loader goes into reverse. Visual guidelines can also be added for more convenience.



Engine Shutdown Secondary Switch

The engine stop switch is incorporated to allow shutdown of the machine when accessing the key switch is not possible.

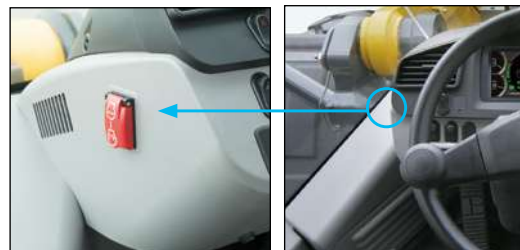

Emergency Stop

The cabin E-Stop provides the operator with immediate access from the operator's seat and is located on the RHS forward cabin pillar.



Auxiliary Input (MP3 Jack) 12 V Outlets

An Aux input for digital devices is standard as well as two 12 volt outlets. These are all located on the front of the right hand console.

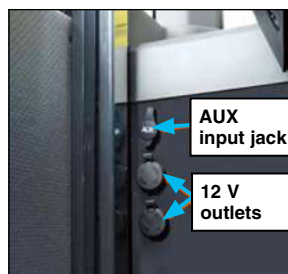

OPERATOR ENVIRONMENT



Easy Entry and Egress

The WA470-8 has an inclined ladder with wide steps and hand holds to ease entry and exit from the cab.

Remote Bucket & Boom Positioner

The operator can set the bucket angle and remote boom positioner from the cab. Both upper and lower boom positions are adjustable in the cab with the push of a button. The bucket positioner can memorise three horizontal settings, allowing the operator to easily change attachments without having to reset the bucket position. In each horizontal setting, the operator can adjust the setting with the switch in the cab. This can help save the operator time when changing attachments.



Remote positioner switch
Boom / Bucket

Automatic Kick-down

The WA470-8 has the ability to automatically shift down to F1. This can be activated through the monitor.



Kick-down switch

Electronically Controlled Suspension System (ECSS)

The Electronically Controlled Suspension System (ECSS) or ride control system uses an accumulator which minimises boom arm shock, giving the operator a much smoother ride. This reduces operator fatigue and reduces material spillage during load and carry operations. ECSS is speed sensitive, meaning that the boom won't move during stationary digging. ECSS is standard on the WA470-8.

Mono Lever With Integrated 3rd Spool Control (optional)

The mono lever option has been designed for improved ergonomics and comfort. When equipped with the optional 3rd spool valve, it allows the operator to control the 3rd spool with the thumb. The 3rd spool valve can be operated in either continuous or proportional flow modes. The mono lever also includes a F-N-R switch.



High Resolution 7-inch Colour LCD Monitor

The machine monitor display various machine information and allows for various settings of the machine. The LCD monitor is a 7-inch colour TFT-LCD and displays maintenance information, operation record, Ecology Guidance record, and other machine data. The switch panel is used to select various screens and the air conditioner control screen. By using the switch panel, you can display various user menus on the LCD screen and adjust the machine settings.

Machine monitor

- | | |
|---------------------------|---|
| 1 LCD unit | 8 Engine coolant temperature gauge |
| 2 LED unit | 9 Hydraulic oil temperature gauge |
| 3 Engine tachometer | 10 Torque converter oil temperature gauge |
| 4 Speedometer | 11 Fuel gauge |
| 5 Ecology gauge | 12 Message pilot lamp |
| 6 Air conditioner display | 13 Pilot lamps |
| 7 Shift indicator | 14 DEF level gauge |

Switch panel

- | | |
|--|---------------------|
| 1 Air conditioner switches / Numeral key pad | 2 Function switches |
|--|---------------------|

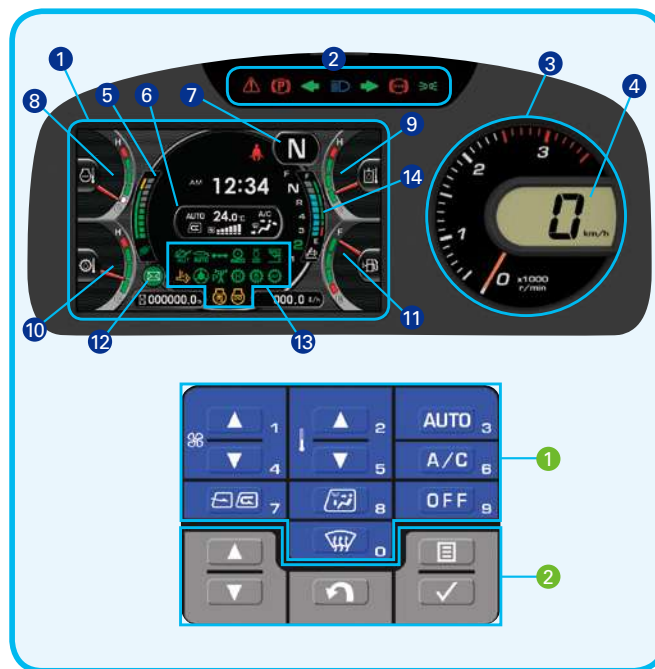

Visual user menu

Pressing the menu switch on the switch panel displays the user menu screen. The menus are grouped for each function, and use easy-to-understand icons which enable the machine to be operated intuitively.

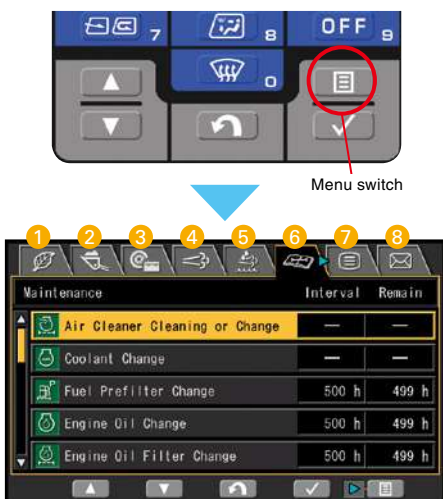

- | |
|---------------------------------------|
| 1 Energy saving guidance |
| 2 Load meter setting (optional) |
| 3 Machine settings |
| 4 Aftertreatment devices regeneration |
| 5 SCR information |
| 6 Maintenance |
| 7 Monitor setting |
| 8 Mail check |

Operator identification function

An operator identification (ID) can be set for each operator, and used to manage operation information of individual machines as KOMTRAX data. Data sent from KOMTRAX can be used to analyse operation status by operator as well as by machine.



Machine monitor with troubleshooting function to minimise downtime

Various meters, gauges and warning functions are centrally arranged on the machine monitor. The monitor simplifies start-up inspection and promptly warns the operator with a lamp and buzzer if any abnormalities should occur. In addition, countermeasures are indicated in 4 levels to ensure safety and help prevent the machine from having major problems. Replacement times for oil and filters are also indicated.



MAINTENANCE FEATURES

Wheel Chocks

Wheel chocks for safe parking during service work.



Automatic Greasing System

6 kg reservoir.



Side-opening Gull-wing Engine Doors

The large gull-wing type engine doors require less effort to open and close thanks to gas assisted struts. The doors provide wide areas of access for ease of daily maintenance. Large steps on each side of the frame enhance accessibility.



Swing-out Type Cooling Fan and Wide Core Radiator

The cooling fan swings out for cleaning. The coolers feature wide spacing of the cooling fins to reduce clogging.



Photos may include optional equipment.

Auto Reversing Fan

The engine cooling fan is hydraulically driven. It can be set to reverse automatically during operation. Fan reverse mode and timing can be controlled through the monitor.



DEF Tank

The DEF tank is located on the right hand side of the machine behind a ladder for easy access. An external sight gauge aids in preventing overflow and spillage while refilling.



Battery Isolation Switch

The battery isolation switch is located in the right side of the engine. This can be used to disconnect power when performing service work on the machine.



Engine Compartment

The WA470-8 engine compartment is designed for easy serviceability. Placement of maintenance items, such as filters, dipsticks, oil fill locations, and aftertreatment devices is all very intuitive.

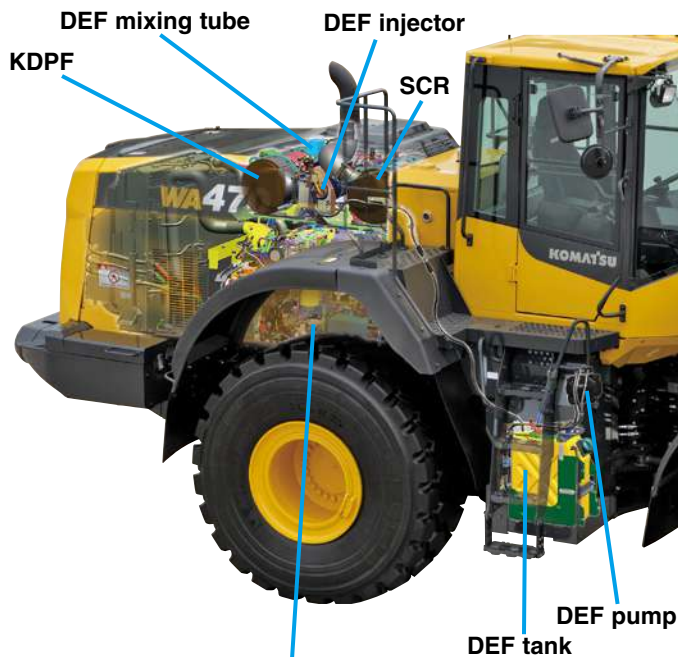

Engine oil fill, Engine oil dipstick, Fuel filter, Fuel pre-filter, Oil filter

Rear Full Fenders (Standard)

The WA470-8 has a rear full fender standard. The plastic rear fenders open outward, keeping the force to open the engine doors low, even when there is mud or snow on the fenders. The fenders swing far out of the way to give the technician easy access to the engine compartment. Mudflaps are also included on the rear fenders.



Air Conditioner Filter

The inside and outside air conditioner filters can be replaced easily without using a tool. The outside filter is located behind a lockable door for security.



Inside air filter

Outside air filter

LED Taillights and E-Stops

LED brake lights and reverse lights provide long bulb life and excellent visibility. External E-Stops are standard and provide ground level access to shut down the machine.



Engine Air Cleaner and Pre-Cleaner

The air cleaner is located on the left-side platform. A Turbo II centrifugal type pre-cleaner for extended filter life and engine protection is standard.



Maintenance Information

“Maintenance time caution lamp” display

When the remaining time to maintenance becomes less than 30 hours*, the maintenance time monitor appears. Pressing the menu switch displays the maintenance screen.

*: The setting can be changed within the range between 10 and 200 hours.



Maintenance screen

Supports the DEF level and refill timing

The DEF level gauge is displayed continuously on the monitor screen. In addition, when the refill timing is reached, the DEF low level guidance appears as a pop up display to inform the operator in real time.



DEF level gauge

DEF low level guidance

KOMTRAX EQUIPMENT MONITORING

GET THE WHOLE STORY WITH
KOMTRAX[®]

✓ WHAT

- KOMTRAX is Komatsu's remote equipment monitoring and management system
- KOMTRAX **continuously monitors and records** machine health and operational data
- Information such as fuel consumption, utilisation, and a detailed history **lowering owning and operating cost**

✓ WHEN

- Know when your machines are **running or idling** and make decisions that will improve your fleet utilisation
- Detailed movement records ensure you know when and where your equipment is moved
- Up to date records allow you to **know when maintenance is due** and help you plan for future maintenance needs

✓ WHERE

- KOMTRAX data **can be accessed virtually anywhere** through your computer, the web or your smart phone
- Automatic alerts keep fleet managers up to date on the latest machine notifications

✓ WHY

- Knowledge is power - **make informed decisions** to manage your fleet better
- Knowing your idle time and fuel consumption will help maximise your machine efficiency
- **Take control of your equipment** - any time, anywhere

✓ WHO

- KOMTRAX is **standard** equipment on all Komatsu construction products



KOMTRAX[®]

For construction and compact equipment.

KOMTRAX Plus[®]

For production and mining class machines.

SPECIFICATIONS



ENGINE

Model.....Komatsu SAA6D125E-7*
 Type.....Water-cooled, 4-cycle
 Aspiration.....Turbo-charged, after-cooled, cooled EGR
 Number of cylinders..... 6
 Bore.....125 mm
 Stroke.....150 mm
 Piston displacement..... 11.04 ltr
 Governor..... All-speed, electronic
 Horsepower:
 SAE J1995..... Gross 204 kW 273 HP
 ISO 9249 / SAE J1349..... Net 203 kW 272 HP
 Rated rpm..... 2000 rpm
 Fan drive method for radiator cooling.....Hydraulic
 Fuel system..... Direct injection
 Lubrication system:
 Method..... Gear pump, force-lubrication
 Filter.....Full-flow type
 Air cleaner..... Dry type with double elements and dust evacuator, plus dust indicator

*EPA Tier 4 Final emissions certified



TRANSMISSION

Torque converter..... 3-elements, 1-stage, 2-phase
 Transmission.....Automatic full-powershift, countershaft type

Travel speed	Forward*	Reverse*
1st	7.6 km/h	7.9 km/h
2nd	13.1 km/h (13.2 km/h)	13.5 km/h (13.7 km/h)
3rd	22.9 km/h (23.6 km/h)	23.6 km/h (24.3 km/h)
4th	36.2 km/h (38.3 km/h)	37.3 km/h (39.0 km/h)

*P-mode Measured with 26.5-R25 tyres (): Lock-up clutch ON



AXLES AND FINAL DRIVES

Drive system..... Four-wheel drive
 Front.....Fixed, semi-floating
 Rear.....Centre-pin support, semi-floating,
 26° total oscillation
 Reduction gear.....Spiral bevel gear
 Differential gear.....Conventional type
 Final reduction gear..... Planetary gear, single reduction



BRAKES

Service brakes..... Hydraulically actuated,
 wet disc brakes actuate on four wheels
 Parking brake.....Wet disc brake
 Emergency brake.....Parking brake is commonly used



STEERING SYSTEM

Type..... Articulated type, fully-hydraulic power steering
 Steering angle..... 35° each direction (40° to max end stop)
 Minimum turning radius
 at the centre of outside tyre.....6630 mm



HYDRAULIC SYSTEM

Steering system:
 Hydraulic pump..... Piston type
 Capacity..... 195 ltr/min at rated rpm
 Relief valve setting.....24.5 MPa 250 kgf/cm²
 Hydraulic cylinders:
 Type..... Double-acting, piston type
 Number of cylinders..... 2
 Bore x stroke..... 90 mm x 441 mm
 Loader control:
 Hydraulic pump..... Piston pump
 Capacity..... 260 ltr/min at rated rpm
 Relief valve setting.....34.3 MPa 350 kgf/cm²
 Hydraulic cylinders:
 Type..... Double-acting, piston type
 Number of cylinders—bore x stroke:
 Lift cylinder..... 2- 140 mm x 764 mm
 Bucket cylinder..... 1- 160 mm x 575 mm
 Control valve..... 2-spool type
 Control positions:
 Boom.....Raise, hold, lower, and float
 Bucket..... Tilt-back, hold, and dump
 Hydraulic cycle time (rated load in bucket)
 Raise..... 5.8 s
 Dump.....1.6 s
 Lower (Empty).....3.1 s



SERVICE REFILL CAPACITIES

Cooling system..... 78 ltr
 Fuel tank..... 380 ltr
 Engine..... 38 ltr
 Hydraulic system..... 173 ltr
 Axle front..... 57 ltr
 Axle rear..... 56 ltr
 Torque converter and transmission..... 65 ltr
 DEF tank..... 36 ltr



BUCKET SELECTION GUIDE

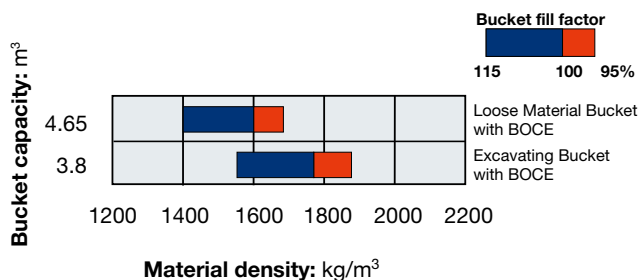

SPECIFICATIONS



DIMENSIONS

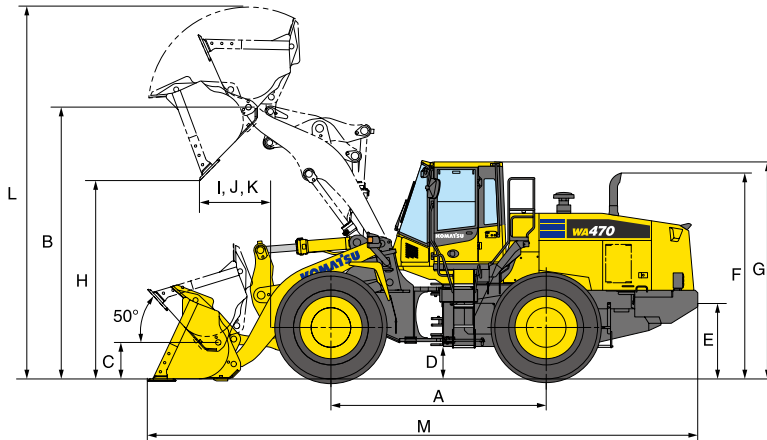

Tread		2300 mm
Width over tyres		3010 mm
A Wheelbase		3450 mm
B Hinge pin height,	Standard Boom	4360 mm
max. height	High Lift Boom	4870 mm
C Hinge pin height,	Standard Boom	585 mm
carry position	High Lift Boom	730 mm
D Ground clearance		525 mm
E Hitch height		1210 mm
F Overall height, top of the stack		3220 mm
G Overall height, ROPS cab		3500 mm

Measured with 26.5-R25 (L3) tyres, ROPS/FOPS cab

	Standard Boom		High Lift Boom
	Excavating Bucket	Loose Material Bucket	General Purpose Bucket
	Straight Edge Bolt-on Cutting Edge	Straight Edge Bolt-on Cutting Edge	Straight Edge Bolt-on Cutting Edge
Bucket capacity: heaped	3.8 m ³	4.65 m ³	3.8 m ³
struck	3.2 m ³	3.9 m ³	3.2 m ³
Bucket width	3170 mm	3170 mm	3170 mm
Bucket weight	2170 kg	2210 kg	2170 kg
Dumping clearance, max. height and 45° dump angle	3235 mm	3055 mm	3750 mm
Reach at max. height and 45° dump angle	1185 mm	1365 mm	1330 mm
Operating height (fully raised)	5910 mm	5960 mm	6415 mm
Overall length (bucket on ground)	9005 mm	9260 mm	9430 mm
Loader clearance circle diameter (bucket at carry, outside corner of bucket)	15260 mm	15390 mm	15780 mm
Digging depth 0°	80 mm	80 mm	215 mm
10°	305 mm	345 mm	440 mm
Static tipping load Straight	20130 kg	20090 kg	16500 kg
40° full turn	17320 kg	17280 kg	14050 kg
Breakout force	203 kN 20710 kgf	168 kN 17140 kgf	186 kN 19018 kgf
Operating weight	24350 kg	24390 kg	25210 kg

* At the end of tooth or B.O.C.E.

All dimensions, weights, and performance values based on SAE J732c and J742b standards.

Static tipping load and operating weight shown include lubricant, coolant, full fuel tank, ROPS cab, and operator.

Machine stability and operating weight affected by counterweight, tyre size, and other attachments.

Apply the following weight changes to operating weight and static tipping load.



STANDARD EQUIPMENT

ENGINE:

- Automatic hydraulic-driven fan with automatic reverse rotation
- Engine, Komatsu SAA6D125E-7 diesel
- Fuel pre-filter with separator
- Komatsu SmartLoader Logic
- Radiator mask, swing out
- Radiator, wider core
- Turbo II engine pre-cleaner with extension

ELECTRICAL SYSTEM:

- Alternator, 90 A
- Batteries, 140 Ah/12V (2), 930 CCA
- Komatsu Auto Idle Shutdown
- Lights
 - Back-up light, LED
 - Flashing beacon, LED with guard
 - Stop and tail light, LED
 - Turn signal, 2 front and 2 rear with hazard switch
 - Working lights, halogen, 2 front cab mount
 - Working lights, halogen, 2 front fender mount
 - Working lights halogen, 2 rear grill mount
- Starting motor, 7.5 kW

CAB:

- 2 x DC12V electrical outlets
- Auto air conditioner
- Colour LCD/TFT multi-monitor
- Door LH and RH egress
- Electronically Controlled Suspension System (ECSS)

- Equipment Management Monitoring System (EMMS)
 - Lights (central warning, brake oil pressure, engine oil pressure, parking brake, cooling fan reverse, KDPF restriction, seat belt caution, Komtrax message)
 - Gauges (engine water temperature, ecology, fuel level, DEF level, hydraulic oil temperature, speedometer/tachometer)
- Floor mat
- Operator seat, reclining, air suspensions type, heated
- Radio, AM/FM with AUX input jack
- Rear defroster, electric
- ROPS/FOPS Cab Level 2
- Seatbelt, two-point retractable, 76mm width
- Steering wheel, tilt and telescopic
- Sun visor, front window
- Windshield washer and wiper, front with intermittent
- Windshield washer and wiper, rear

SAFETY EQUIPMENT:

- Back-up alarm
- Battery isolation switch
- Colour rear view camera and monitor
- Emergency stop switches (3)
- Horn, electric
- Parking brake, electric
- Rear view mirrors, outside (2) inside (2)
- Service brakes, wet disk type
- Wheel chocks, steel type

TYRES:

- 26.5R25 Michelin L3 XHA2 tyres

OTHER:

- 2-spool valve for boom and bucket control
- Auto shift transmission with mode select system
- Automatic greasing system
- Auxiliary steering (SAE)
- Boom kick-out, in-cab adjustable
- Brake cooling system
- Bucket positioner, in-cab adjustable, 3 positions
- Counterweight, standard and additional
- Cutting edge (bolt-on type)
- EPC fingertip controls with F-N-R switch, 2 levers
- Front fenders
- KOMTRAX® Level 5
- Lift cylinders and bucket cylinder
- Loader linkage with standard lift arm
- Lock-up torque converter
- Powertrain underguard
- Rear full fenders
- Transmission, four forward and four reverse
- Vandalism protection kit, padlocks for battery box (2)



OPTIONAL EQUIPMENT

- 3-spool valve with lever and piping
- Additional LED lighting
- Bluetooth media system
- Clean air cab pressurisation systems
- Fire extinguishers
- Fire suppression systems
- Hi vis decals

- High lift boom
- Joystick/wheel steering control system
- Limited slip differential (F&R)
- Mono-lever loader control with transmission F-N-R switch
- Reverse sensor
- SMART Alarm Broadband reverse alarm

- UHF/CB Radio
- Various bucket options
- Various scale systems
- Window Tinting

WA470-8

www.Komatsu.com.au

Printed in Australia

KOMATSU[®]

Form No: ZESS004100_AUGUST2018

Materials and specifications are subject to change without notice.
KOMATSU is a trademark of Komatsu Ltd. Japan.