

# KOMATSU®

# WA500-8

EPA Tier 4 Final Engine

Australia & New Zealand Specifications

WHEEL LOADER

WA500



Photos may include optional equipment.

**NET HORSEPOWER**

263 kW/ 353 HP @1900 rpm

**OPERATING WEIGHT**

36,290 – 38,125 kg

**BUCKET CAPACITY**

4.5 – 7.0 m<sup>3</sup>

# WALK-AROUND

WA500-8



Photos may include optional equipment.

## NET HORSEPOWER

263 kW/ 353 HP @ 1900 rpm

## OPERATING WEIGHT

36,290 – 38,125 kg

## BUCKET CAPACITY

4.5 – 7.0 m<sup>3</sup>



## PERFORMANCE, DURABILITY AND FUEL ECONOMY

### Large capacity torque converter with lock-up provides:

- Quick acceleration
- Lock-up in 2<sup>nd</sup>, 3<sup>rd</sup> and 4<sup>th</sup> gear

### Komatsu SmartLoader Logic helps reduce fuel consumption with no decrease in production.

A powerful **Komatsu SAA6D140E-7 engine** provides a net output of 264 kW 357 HP with up to 5% improved fuel consumption. This engine is EPA Tier 4 Final emissions certified.

**Komatsu Variable Geometry Turbocharger (KVGIT)** uses a hydraulic actuator to provide optimum air flow under all speed and load conditions.

**Komatsu Diesel Particulate Filter (KDPF) and Selective Catalytic Reduction (SCR) systems** reduce particulate matter and NOx, while providing automatic regeneration that does not interfere with daily operation.

### Fluid neutral or better

Consumption of fuel and diesel exhaust fluid (DEF) is less than or equivalent to the amount of fuel consumed by the prior model.

### Cooling

- Hydraulically driven, variable-speed fan
- Auto-reversing fan is standard
- Wider core coolers resist clogging
- Swing-out fan for easy cleaning

**Remote boom and bucket positioners** allow kickouts to be set from inside the cab.

**Variable displacement piston pumps with Closed-Centre Load Sensing System (CLSS)** provide quick response and smooth operation to maximise productivity.

### Rearview monitoring system (standard)

**Advanced diagnostic system** continuously monitors machine operation and vital systems to identify machine issues and assist with troubleshooting.

**Transmission Mode Select System (3 modes)** allows shifting mode to be matched more efficiently to varying work applications.

### Enhanced working environment:

- New high capacity, heated, air suspension seat,
- Seat mounted EPC controls with F-N-R switch
- Two 12V power outlets

**New front fender** is changed from steel to composite material for resistance to scratches and impact.

**Full rear fenders (standard)** swing open for easy access to maintenance points.



### Large LCD colour monitor panel:

- 7" high resolution, multi-colour screen is easy to read
- Integrated load meter system displays payload data directly on the monitor panel (optional)
- Includes an ecology gauge and provides "Ecology Guidance" for greater fuel efficiency
- Onboard diagnostics do not require use of a laptop computer
- Easy-to-navigate menus allow operators to change settings, review machine performance records and track periodic maintenance items.

**Komatsu Auto Idle Shutdown** helps reduce idle time and operating costs.

### External mounting of engine air filter (above rear LH fender)

provides easy access for maintenance.

**KOMTRAX®** equipped machines can send location, Service meter readings and operation maps to a secure website or smart phone utilising wireless technology. Machines also relay error codes, cautions, maintenance items, fuel & Diesel Exhaust Fluid (DEF) levels, payload data and much more.

**Lockable battery isolation switch** allows a technician to disconnect the power supply before servicing the machine.

**Operator Identification System** can track machine operation for up to 100 operators.

# PERFORMANCE FEATURES

## KOMATSU NEW ENGINE TECHNOLOGIES

### New Tier 4 Final Engine

The Komatsu SAA6D140E-7 engine is EPA Tier 4 Final emissions certified and provides exceptional performance, while reducing fuel consumption. Based on Komatsu proprietary technologies developed over many years, this new diesel engine reduces nitrogen oxides (NOx) by more than 80%, when compared to Tier 4 interim levels.

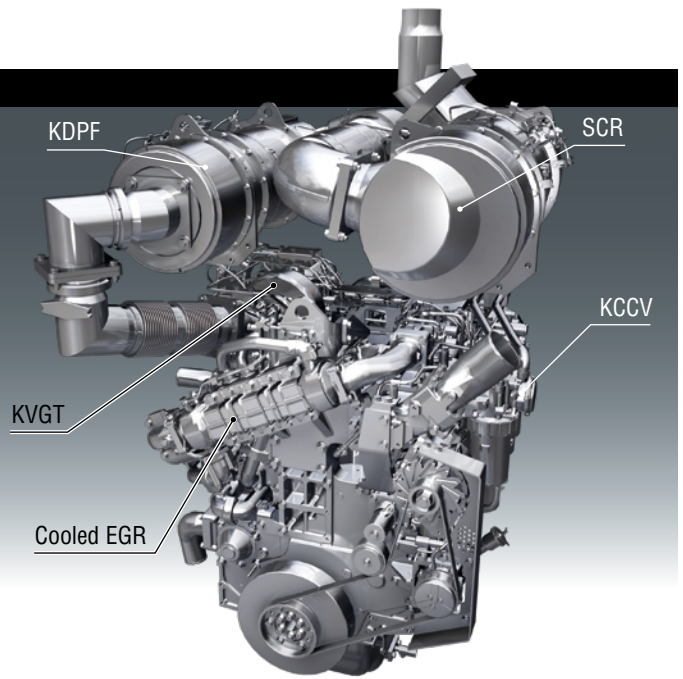

### Technologies Applied to New Engine Heavy-Duty Aftertreatment System

This new system combines a Komatsu Diesel Particulate Filter (KDPF) and Selective Catalytic Reduction (SCR). The SCR NOx reduction system injects the correct amount of Diesel Exhaust Fluid (DEF) at the proper rate, thereby decomposing NOx into non-toxic water vapour (H<sub>2</sub>O) and nitrogen gas (N<sub>2</sub>).

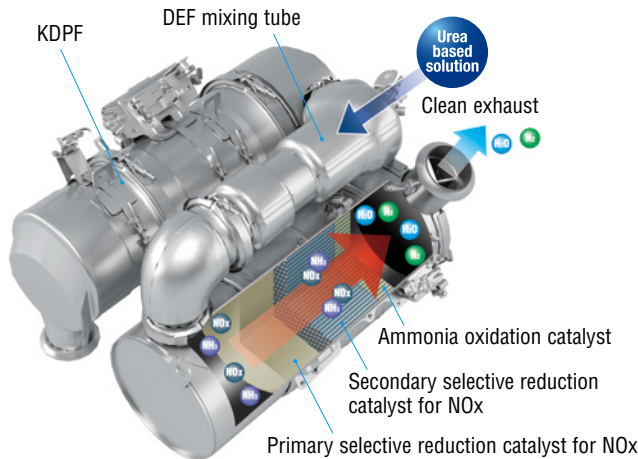

### Advanced Electronic Control System

The electronic control system performs high-speed processing of all signals from sensors installed in the vehicle, providing total control of equipment. Engine condition information is displayed on the monitor inside the cab, providing necessary information to the operator. Additionally, managing the information via KOMTRAX helps customers keep up with required maintenance.

### Komatsu Variable Geometry Turbocharger (KVG) System

The KVG system features proven Komatsu design hydraulic technology for variable control of air-flow and supplies optimal air according to load conditions. The upgraded version provides better exhaust temperature management.

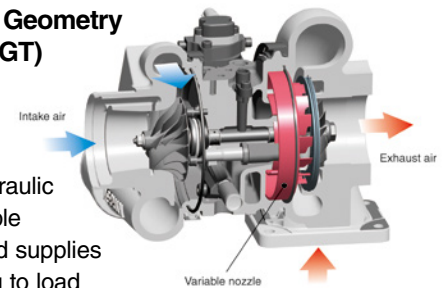

### Heavy-Duty Cooled Exhaust Gas Recirculation (EGR) System

The system recirculates a portion of exhaust gas into the air intake and lowers combustion temperatures, thereby reducing NOx emissions. EGR gas flow has been decreased for Tier 4 Final with the addition of SCR technology. The system dramatically reduces NOx, while helping cut fuel consumption below Tier 4 Interim levels.

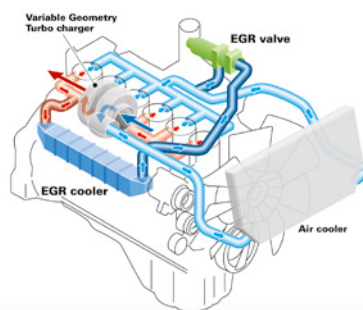

### Heavy-duty High-Pressure Common Rail (HPCR) fuel injection system

The system is specifically designed to achieve the optimal injection of fuel for near-complete combustion, which helps reduce particulate matter emissions.

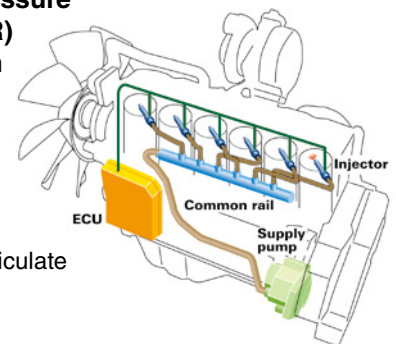

## Komatsu SmartLoader Logic

The WA500-8 features Komatsu SmartLoader Logic, which controls engine torque to match machine demands. For example, engine torque needs are higher for digging in V-shape loading, but lower when driving with an empty bucket. This system optimises the engine torque for all applications to minimise fuel consumption. Komatsu SmartLoader Logic functions automatically and doesn't interfere with operation, saving fuel without decreasing production.

## Large-capacity Torque Converter

The Komatsu-designed power train features a large capacity torque converter for optimum efficiency. The WA500-8 has improved efficiency in V-shape loading applications because the increased tractive effort does not require full throttle. The large capacity torque converter allows the loader to up-shift gears faster for improved acceleration and hill climbing ability. The WA500-8 achieves high gear ranges and maintains high travel speed when working in load-and-carry applications. In most applications, production is increased and fuel consumption is reduced, resulting in improved fuel efficiency.

## Dual-mode Engine Power Select System

This wheel loader offers two selectable operating modes — Power (P) and Economy (E).

- P Mode: This mode provides maximum power output for hard-digging operation or hill climbing.
- E Mode: This mode provides maximum fuel efficiency for general loading.



- 1 Dual mode engine power selection switch
- 2 Transmission shift mode selector switch
- 3 Torque converter lock-up switch

## Enhanced Lock-up

The Komatsu designed torque converter with lock-up is standard on the WA500-8. The lock-up function activates in 2nd, 3rd and 4th gears. The lock-up torque converter is effective for both load and carry applications and V-shape loading in lower gears. Komatsu SmartLoader Logic reduces the clutch engagement shock of lock-up by controlling engine torque. The lock-up torque converter, combined with Komatsu SmartLoader Logic, results in low fuel consumption and high travel speeds in load and carry, and even some V-cycle loading applications.

## Automatic Transmission with Mode Select System

This operator-controlled system allows the operator to select manual shifting or two levels of automatic shifting (low, and high). Auto L mode is for fuel-saving operation, with the gear-shift timing set at lower speeds than Auto H mode.

## Closed-Centre Load Sensing System (CLSS) Variable Displacement Piston Pump

The variable displacement piston pump, combined with the Closed-Centre Load Sensing System (CLSS), delivers hydraulic flow just as the job requires, preventing wasted hydraulic flow. Minimised loss contributes to better fuel economy.

## Komatsu Auto Idle Shutdown

In order to reduce unwanted idle time, Komatsu offers Komatsu auto idle shutdown. This function will shut the engine off and apply the parking brake and hydraulic lock after a preset idle time limit.

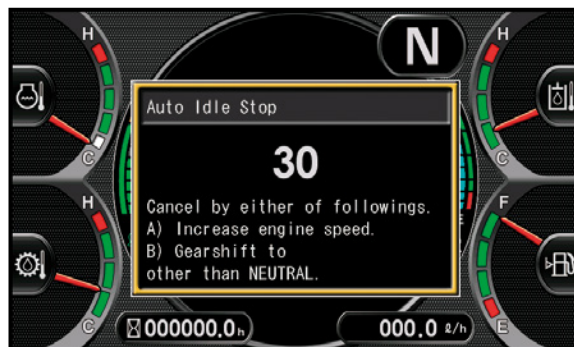



# OPERATOR ENVIRONMENT



Photos may include optional equipment.

WA500-8

## New Operator Seat with Electronic Pilot Control (EPC) Levers

A new standard, heated, air-suspension seat provides enhanced support on rough roads and dampens machine vibrations, providing a more comfortable ride for the operator. An EPC-lever console is built into, and moves with, the seat. The angle of the armrest is fully adjustable for optimum operator comfort. A secondary F-N-R switch is incorporated in to work equipment lever configurations.



## Tiltable / Telescopic Steering Wheel (Optional)

The operator can tilt and telescope the steering wheel to allow maximum comfort and control. The two-spoke steering wheel allows maximum visibility of the monitor panel and the forward work environment.



## Low Noise Design

Operator's ear noise level : 72 dB(A)  
Dynamic noise level (outside): 109 dB(A)

The large ROPS/FOPS cab is mounted with Komatsu's unique viscous mounts. The low-noise engine, hydraulically-driven fan, and hydraulic pumps are mounted with rubber cushions. The cab sealing is improved to provide a quiet, low-vibration, low dust and comfortable operating environment.

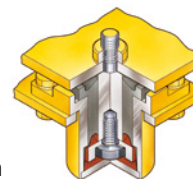

## Advanced Joystick Steering System (AJSS)

Advanced Joystick Steering System allows steering and directional selection to be controlled by wrist and finger control. With the feedback function, the machine steering angle is exactly the same angle as the lever tilt angle.

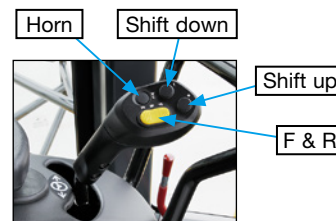



Machine Monitor

Colour Rear View Monitor

Multi-Switch Panel

Photos may include optional equipment.

**Standard Rear View Monitoring System**

The dedicated, full-colour monitor on the right side of the cab provides the operator with a rear view of the machine. This monitor can be always on or only on when the loader shifts into reverse. Guidelines provide the operator with visual cues for the width of the loader.

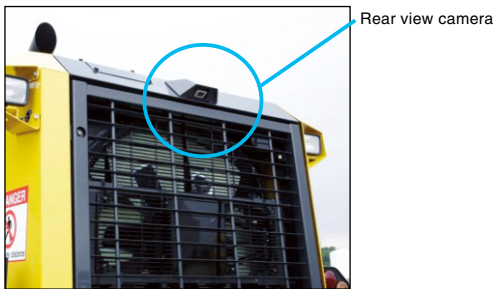

**Engine Shutdown Secondary Switch**

The engine stop switch enables machine shutdown when accessing the key switch is not possible.



Engine shutdown secondary switch

**Auxiliary Input (MP3 Jack)  
12 V Outlets**

An Aux input for audio devices is standard, as well as two 12 volt outlets. These are all located on the front of the right-hand console.

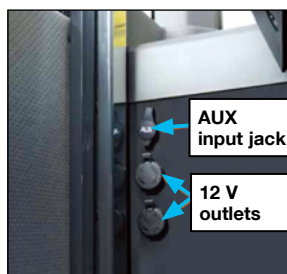

**Emergency Stop**

The cabin E-Stop provides the operator with immediate access from the operator's seat and is located on the RHS forward cabin pillar.





# OPERATOR ENVIRONMENT



## Easy Entry and Exit

The WA500-8 has an inclined ladder with wide steps and hand holds to ease entry and exit from the cab.

## Remote Bucket & Boom Positioner

The operator can set the bucket angle and remote boom positioner from the cab. Both upper and lower boom limits are adjustable in the cab with the push of a button. The bucket positioner can store three horizontal settings, allowing the operator to easily change attachments without resetting the bucket level position.

Remote positioner switch  
Boom / Bucket



## Automatic Kick-down

The WA500-8 has the ability to automatically downshift to F1, eliminating the need for the operator to manually downshift when entering the pile. This can be activated through the monitor.

Kick-down switch



## Electronically Controlled Suspension System

The electronically controlled suspension system, or ride control system, uses an accumulator to minimise boom arm shock, giving the operator a much smoother ride. This reduces operator fatigue and material spillage during load and carry operations. The electronically controlled suspension system is speed sensitive, meaning the boom won't move during low speed digging. This feature is standard on the WA500-8.

## Mono Lever With Integrated 3rd Spool Control (option)

The mono lever option has been designed for improved ergonomics and comfort. When equipped with the optional 3rd spool valve, it allows the operator to control the 3rd spool with the thumb. The 3rd spool valve can be operated in either continuous or proportional flow modes. The mono lever also includes an F-N-R switch.

## Automatic Digging System

The new automatic digging system actuates the bucket tilt and lifting operations by sensing the pressure applied to the work equipment. This system can alleviate operator's fatigue and optimise bucket load. This system is activated through the LCD colour monitor panel.

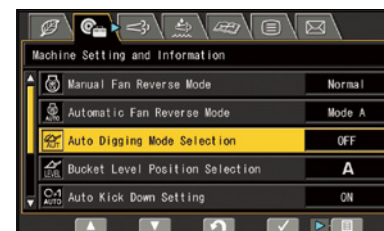



### High Resolution 7-inch Colour LCD Monitor

The 7-inch colour TFT-LCD monitor can display maintenance information, operational records, ecology-guidance records and other machine data. The switch panel is used to select screens and adjust air conditioner and environmental settings.

#### Machine monitor

- 1 LCD unit
- 2 LED unit
- 3 Engine tachometer
- 4 Speedometer
- 5 Ecology gauge
- 6 Air conditioner display
- 7 Shift indicator
- 8 Engine coolant temperature gauge
- 9 Hydraulic oil temperature gauge
- 10 Torque converter oil temperature gauge
- 11 Fuel gauge
- 12 Message pilot lamp
- 13 Pilot lamps
- 14 DEF level gauge

#### Switch panel

- 1 Air conditioner switches / Numeral key pad
- 2 Function switches

### Visual User Menu

Pressing the menu button on the switch panel accesses the user-menu screen. The menus are grouped by function, with easy-to-understand, intuitive icons for easier machine operation.

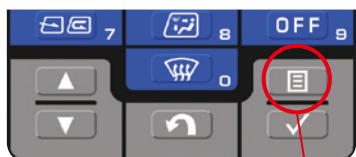

Menu switch

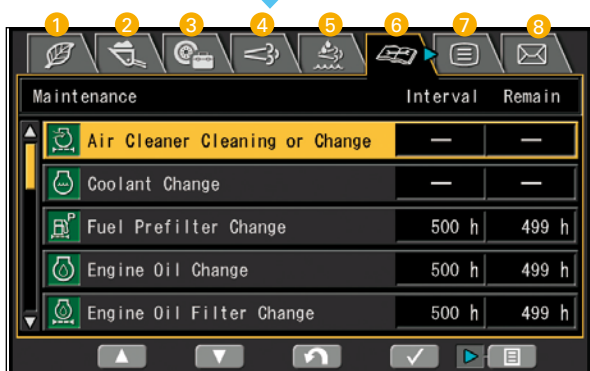

- 1 Energy saving guidance
- 2 Load-meter setting (optional)
- 3 Machine settings
- 4 Aftertreatment devices regeneration
- 5 SCR information
- 6 Maintenance
- 7 Monitor setting
- 8 Mail check

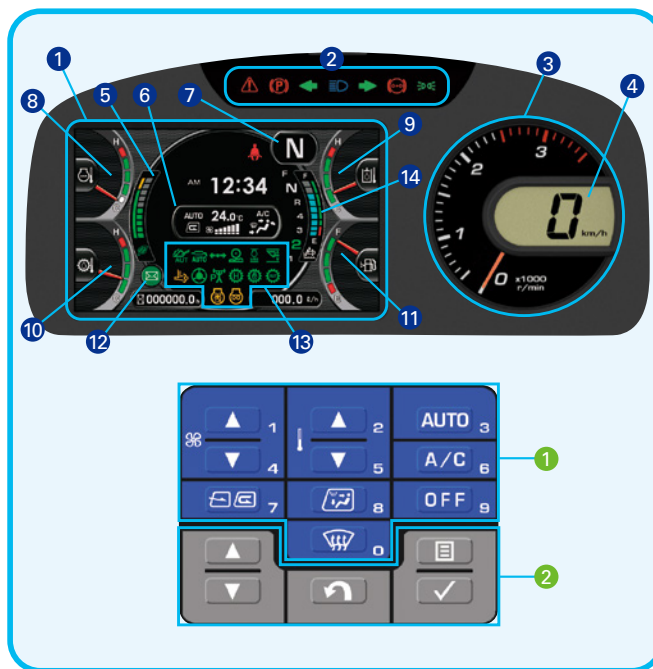

### Operator Identification Function

An operator identification (ID) code can be set for each operator, and used to manage operation information of individual machines through KOMTRAX. Data sent from KOMTRAX can be used to analyse operation status by operator job, as well as by machine.



### Monitor Panel with Troubleshooting Function Minimises Downtime

Various meters, gauges and warning functions are centrally arranged on the monitor panel. The monitor simplifies start-up inspection and warns the operator with a lamp and buzzer if any abnormalities occur. Warnings are indicated in four levels, which the operator must acknowledge and clear. Replacement times for oil and filters are also indicated.

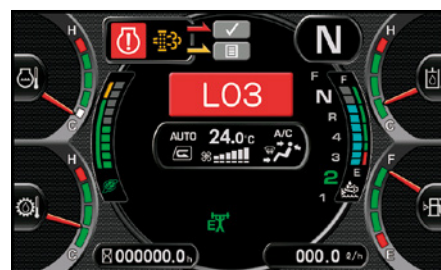

# MAINTENANCE FEATURES

## Service Centre for Oils & Lubricants

Ground level, to provide easier servicing of the engine, transmission and hydraulic oils.



## Automatic Greasing System

10kg reservoir with ground level refill.



## Side-opening Gull-wing Engine Doors

The large, gull-wing-type engine doors require minimal effort to open and close, thanks to gas assisted struts. The doors make access and daily maintenance easy. Large steps on each side of the frame also enhance accessibility.



## Swing-Out Type Cooling Fan and Wider Core Radiator

The cooling fan swings out for easier cleaning. The coolers feature wider-spaced cooling fins to reduce clogging.



## Auto Reversing Fan

The engine cooling fan is hydraulically driven. It can be set to reverse automatically during operation. Fan reverse mode and timing can be controlled through the monitor.



## DEF Tank

The DEF tank is easily accessed behind the RH side ladder. A convenient external sight gauge helps prevent overflow and spillage while refilling.



## Lockable Battery Isolation switch and Jump Start Receptacle.

The lockable battery isolator is located on the right-hand side at the rear of the machine. This can be used to disconnect power when performing service work on the machine, and personal tag-out devices can be utilised to ensure compliance to site and safety regulations. The jump start receptacle is also located here.





### Engine Compartment

The WA500-8 engine compartment is designed for easy serviceability. Placement of maintenance items, such as filters, dipsticks, and oil-fill locations are laid out for easy-to-reach, ground-level access.

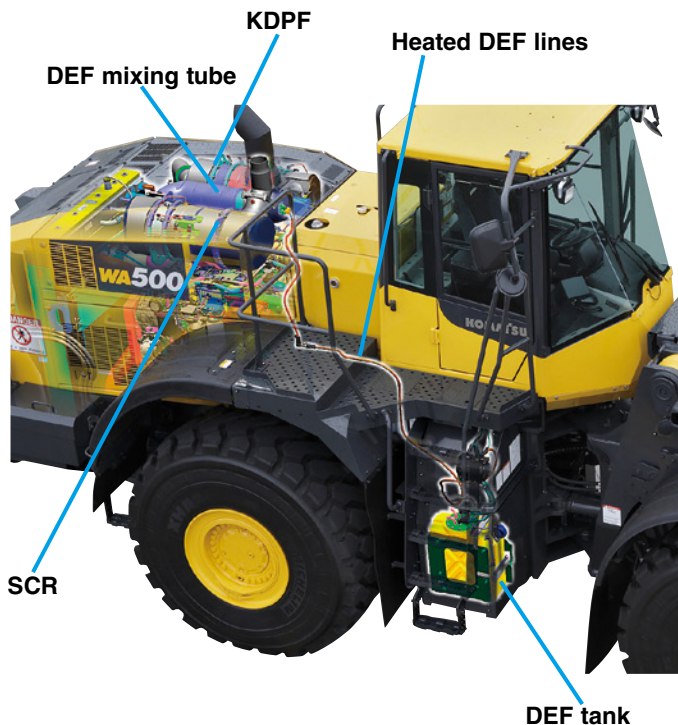

### Rear Full Fenders (Standard)

Full rear fenders are standard on the WA500-8. The plastic rear fenders open outward, keeping the force required to open them low, even when covered with mud or snow. The fenders swing out of the way to give technicians easy access to the engine compartment. Mud flaps are also included on the fenders for additional machine protection.



Photos may include optional equipment.

### Cab Air Filter

The inside and outside air filters can be replaced easily without need for tools. The outside filter is located behind a lockable door for security.

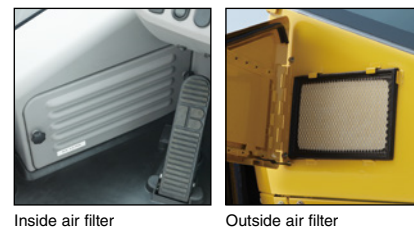

Inside air filter

Outside air filter

### LED Taillights and E-Stops

LED brake lights and reverse lights provide long bulb life and excellent visibility. External E-Stops are standard and provide ground level access to shut down the machine.



### Engine Air Cleaner and Pre-Cleaner

The air cleaner is located on the left-side platform. A Turbo II centrifugal type pre-cleaner for extended filter life and engine protection is standard.



### Maintenance Information

#### “Maintenance time caution lamp” display

When the time before required maintenance dips below 30 hours\*, the maintenance-time monitor appears. Pressing the menu switch displays the maintenance screen.

\* : The setting can be changed within the range between 10 and 200 hours.



Maintenance screen

#### Supports DEF level and refill timing

The DEF level gauge is displayed continuously on the monitor panel. In addition, when the refill timing is reached, the DEF-low-level icon appears to alert the operator.

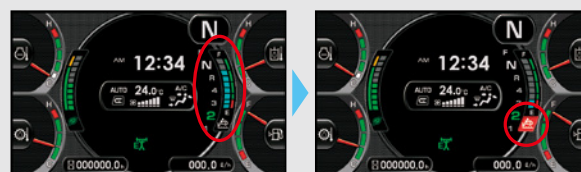

DEF level gauge

DEF low level guidance

# KOMTRAX EQUIPMENT MONITORING

GET THE WHOLE STORY WITH  
**KOMTRAX**<sup>®</sup>

## ✓ WHAT

- KOMTRAX is Komatsu's remote equipment monitoring and management system
- KOMTRAX **continuously monitors and records** machine health and operational data
- Information such as fuel consumption, utilisation, and a detailed history **lowering owning and operating cost**

## ✓ WHEN

- Know when your machines are **running or idling** and make decisions that will improve your fleet utilisation
- Detailed movement records ensure you know when and where your equipment is moved
- Up to date records allow you to **know when maintenance is due** and help you plan for future maintenance needs

## ✓ WHERE

- KOMTRAX data **can be accessed virtually anywhere** through your computer, the web or your smart phone
- Automatic alerts keep fleet managers up to date on the latest machine notifications

## ✓ WHY

- Knowledge is power - **make informed decisions** to manage your fleet better
- Knowing your idle time and fuel consumption will help maximise your machine efficiency
- **Take control of your equipment** - any time, anywhere

## ✓ WHO

- KOMTRAX is **standard** equipment on all Komatsu construction products



**KOMTRAX**<sup>®</sup>

For construction and compact equipment.

**KOMTRAX Plus**<sup>®</sup>

For production and mining class machines.



# SPECIFICATIONS



## ENGINE

Model..... Komatsu SAA6D140E-7\*  
 Type..... Water-cooled, 4-cycle  
 Aspiration..... Variable geometry turbo-charged, after-cooled, cooled EGR  
 Number of cylinders..... 6  
 Bore..... 140 mm  
 Stroke..... 165 mm  
 Piston displacement..... 15.24 ltr  
 Governor..... All-speed, electronic  
 Horsepower:  
   SAE J1995..... Gross 266 kW 357 HP  
   ISO 9249 / SAE J1349..... Net 263 kW 353 HP  
 Rated rpm..... 1900 rpm  
 Fan drive method for radiator cooling..... Hydraulic  
 Fuel system..... Direct injection  
 Lubrication system:  
   Method..... Gear pump, force-lubrication  
   Filter..... Full-flow type  
 Air cleaner..... Dry type with double elements and dust evacuator, plus dust indicator

\*EPA Tier 4 Final emissions certified



## TRANSMISSION

Torque converter..... three-elements, one-stage, two-phase  
 Transmission..... Full-powershift, planetary type

Travel speed	Forward*	Reverse*
<b>1st</b>	7.5 km/h	8.5 km/h
<b>2nd</b>	12.9 km/h (13.1 km/h)	12.9 km/h (13.0 km/h)
<b>3rd</b>	22.2 km/h (23.7 km/h)	24.7 km/h (26.6 km/h)
<b>4th</b>	35.5 km/h (37.3 km/h)	38.0 km/h (38.0 km/h)

\*P-mode Measured with 29.5-25 tyres ( ): Lock-up clutch ON



## AXLES AND FINAL DRIVES

Drive system..... Four-wheel drive  
 Front..... Fixed, full-floating  
 Rear..... Centre-pin support, full-floating, 20° total oscillation  
 Reduction gear..... Spiral bevel gear  
 Differential gear..... Conventional type  
 Final reduction gear..... Planetary gear, single reduction



## BRAKES

Service brakes..... Hydraulically actuated, wet disc brakes actuate on four wheels  
 Parking brake..... Wet disc brake  
 Emergency brake..... Parking brake is commonly used



## STEERING SYSTEM

Type..... Articulated type, fully-hydraulic power steering  
 Steering angle..... 36° (40° to max end stop)  
 Minimum turning radius at the centre of outside tyre..... 7050 mm



## HYDRAULIC SYSTEM

Steering system:  
 Hydraulic pump..... Piston type  
 Capacity..... 120 ltr/min at rated rpm  
 Relief valve setting..... 24.5 MPa 250 kgf/cm<sup>2</sup>  
 Hydraulic cylinders:  
   Type..... Double-acting, piston type  
   Number of cylinders..... 2  
   Bore x stroke..... 100 mm x 486 mm  
 Loader control:  
 Hydraulic pump..... Piston pump  
 Capacity..... 320 ltr/min at rated rpm  
 Relief valve setting..... 34.3 MPa 350 kgf/cm<sup>2</sup>  
 Hydraulic cylinders:  
   Type..... Double-acting, piston type  
   Number of cylinders—bore x stroke:  
     Boom cylinder..... 2- 160 mm x 898 mm  
     Bucket cylinder..... 1- 185 mm x 675 mm  
   Control valve..... 2-spool type  
 Control positions:  
   Boom..... Raise, hold, lower, and float  
   Bucket..... Tilt-back, hold, and dump  
 Hydraulic cycle time (rated load in bucket)  
   Raise..... 7.2 s  
   Dump..... 1.7 s  
   Lower (Empty)..... 4.2 s



## SERVICE REFILL CAPACITIES

Cooling system..... 110 ltr  
 Fuel tank..... 473 ltr  
 Engine..... 37 ltr  
 Hydraulic system..... 337 ltr  
 Axle (each front and rear)..... 95 ltr  
 Torque converter and transmission..... 71 ltr  
 DEF tank..... 36 ltr



## BUCKET SELECTION GUIDE

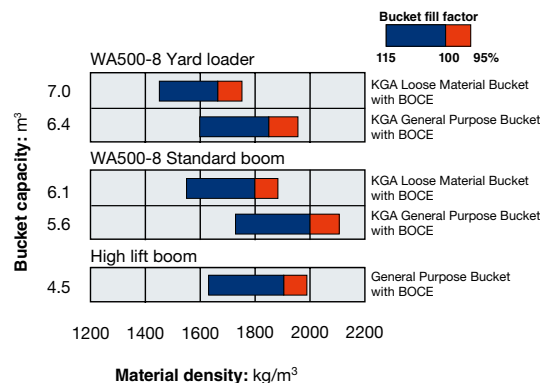

# SPECIFICATIONS



## DIMENSIONS

Measured with 29.5 R25 (L5) tyres.

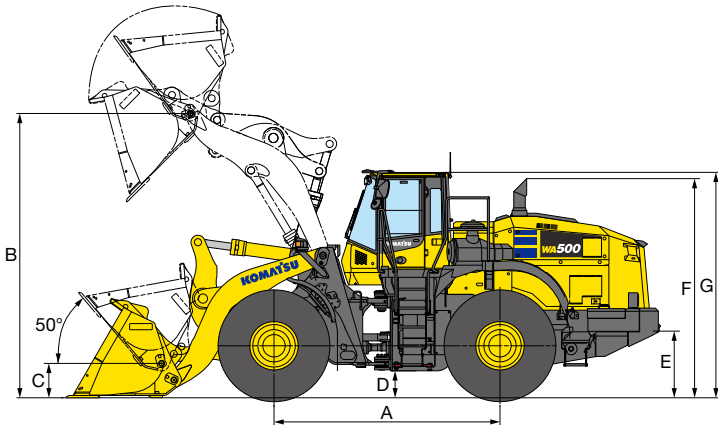

Tread width (centre of tread to centre of tread)	2400 mm
Width over tyres	3190 mm
A Wheelbase	3780 mm
B Hinge pin height,	Standard Boom 4755 mm
max. height	High Lift Boom 5165 mm
C Hinge pin height,	Standard Boom 575 mm
carry position	High Lift Boom 700 mm
D Ground clearance	450 mm
E Hitch height	1115 mm
F Overall height, top of the stack	3665 mm
G Overall height, ROPS cab	3785 mm

	Standard		Yard Loader		High Lift Boom
	KGA General Purpose Bucket	KGA Loose Material Bucket	KGA General Purpose Bucket	KGA Loose Material Bucket	General Purpose Bucket
	Straight Edge Bolt-on Cutting Edge	Straight Edge Bolt-on Cutting Edge	Straight Edge Bolt-on Cutting Edge	Straight Edge Bolt-on Cutting Edge	Straight Edge Bolt-on Cutting Edge
Bucket capacity: heaped	5.6 m <sup>3</sup>	6.1 m <sup>3</sup>	6.4 m <sup>3</sup>	7.0 m <sup>3</sup>	4.5 m <sup>3</sup>
struck	4.9 m <sup>3</sup>	5.3 m <sup>3</sup>	5.6 m <sup>3</sup>	6.1 m <sup>3</sup>	3.7 m <sup>3</sup>
Bucket width	3400 mm	3400 mm	3400 mm	3510 mm	3400 mm
Bucket weight	3725 kg	3825 kg	3880 kg	4190 kg	2885 kg
Dumping clearance, max. height and 45° dump angle	3315 mm	3270 mm	3235 mm	3185 mm	3890 mm
Reach at max. height and 45° dump angle	1530 mm	1560 mm	1600 mm	1655 mm	1435 mm
Operating height (fully raised)	6595 mm	6695 mm	6760 mm	6820 mm	6715 mm
Overall length (bucket on ground)	9955 mm	10005 mm	10055 mm	10130 mm	10130 mm
Loader clearance circle diameter (bucket at carry, outside corner of bucket)	16610 mm	16635 mm	16665 mm	16795 mm	16630 mm
Digging depth: 0°	135 mm	135 mm	135 mm	135 mm	210 mm
10°	440 mm	445 mm	460 mm	470 mm	470 mm
Static tipping load: straight	28070 kg	27920 kg	28910 kg	28490 kg	24075 kg
40° full turn	25365 kg	25220 kg	26025 kg	25615 kg	21700 kg
Breakout force	241 kN 24600 kgf	234 kN 23900 kgf	267 kN 27200 kgf	257 kN 26200 kgf	286 kN 29140 kgf
Operating weight	36965 kg	37065 kg	37815 kg	38125 kg	36290 kg

\* At the end of tooth or B.O.C.E.

All dimensions, weights, and performance values based on SAE J732c and J742b standards.

Static tipping load and operating weight shown include lubricant, coolant, full fuel tank, ROPS cab, and operator.

Machine stability and operating weight affected by counterweight, tyre size, and other attachments.

Apply the following weight changes to operating weight and static tipping load.





## STANDARD EQUIPMENT

### ENGINE:

- Automatic hydraulic-driven fan with automatic reverse rotation
- Engine, Komatsu SAA6D140E-7 diesel
- Fuel pre-filter with separator
- Komatsu SmartLoader Logic
- Radiator mask, swing out
- Radiator, wider core
- Turbo II engine pre-cleaner with extension

### ELECTRICAL SYSTEM:

- Alternator, 90 A
- Batteries, 160Ah/ 12V (2)
- Komatsu Auto Idle Shutdown
- Lights
  - Back-up light, LED
  - Flashing beacon, LED with guard
  - Stop and tail light, LED
  - Turn signal, two front and two rear with hazard switch
  - Working lights, 2x halogen, 2x LED, front cab mount
  - Working lights, halogen, two front fender mount
  - Working lights LED, two rear cab mount
- Starting motor, 11kW

### CAB:

- 2 x DC12V electrical outlets
- Advanced Steering System
- Auto air conditioner
- Colour LCD/TFT multi-monitor
- Door LH and RH egress
- Electronically Controlled Suspension System (ECSS)

- Equipment Management Monitoring System (EMMS)
  - Lights (central warning, brake oil pressure, engine oil pressure, parking brake, cooling fan reverse, KDPF restriction, seat belt caution, Komtrax message)
  - Gauges (engine water temperature, ecology, fuel level, DEF level, hydraulic oil temperature, speedometer/tachometer)
- Floor mat
- Operator seat, reclining, air suspensions type, heated
- Radio, AM/FM with AUX input jack
- Rear defroster, electric
- ROPS/FOPS Cab Level 2
- Seatbelt, two-point retractable, 76mm width
- Sun visor, front window
- Windshield washer and wiper, front with intermittent
- Windshield washer and wiper, rear

### SAFETY EQUIPMENT:

- Back-up alarm
- Colour rear view camera and monitor
- Emergency stop switches (3)
- Horn, electric
- Lockable battery isolation switch
- Mount provision for fire suppression system
- Parking brake, electric
- Rear view mirrors, outside (2) inside (2)
- Service brakes, wet disk type

### TYRES:

- 29.5R25 L5 radial tyres

### OTHER:

- 2-spool valve for boom and bucket control
- Advanced steering system
- Auto shift transmission with mode select system
- Automatic digging system
- Automatic greasing system with ground refill
- Auxiliary steering (SAE)
- Boom kick-out, in-cab adjustable
- Brake cooling system
- Bucket positioner, in-cab adjustable, 3 positions
- Counterweight, standard and additional (YL: Log C/Weight)
- EPC fingertip controls with F-N-R switch, two levers
- Front fenders
- Jump start receptacle
- KOMTRAX® Level 5
- Lift cylinders and bucket cylinder
- Loader linkage with standard lift arm
- Lock-up torque converter
- Powertrain under guard
- Rear full fenders
- Service centre for engine, hydraulic and transmission oils
- Transmission, four forward and four reverse
- Vandalism protection kit



## OPTIONAL EQUIPMENT

- 3-spool valve with lever and piping
- Additional LED lighting
- Bluetooth media system
- Clean air cab pressurisation systems
- Factory load meter (scale system)
- Fire extinguishers
- Fire suppression systems
- Hi vis decals
- High lift boom
- Limited slip differential (F&R)
- Local Scale system options
- Mono-lever loader control with transmission F-N-R switch
- Reverse sensor
- SMART Alarm Broadband reverse alarm
- Steering wheel, tilt and telescopic
- UHF/CB Radio
- Various bucket options
- Window tinting
- Wheel chocks, steel type

